

Powered by



GPL 12120 ▶ 12V 12Ah

GPL 12120 is a general purpose battery up to 8 years in standby service or more than 260 cycles at 100% discharge in cycle service . As with all CSB batteries, all are rechargeable , highly efficient , leak proof and maintenance free.



► Specification

Cells Per Unit	6
Voltage Per Unit	12
Capacity	12 Ah @ 20hr-rate to 1.75V per cell @25 °C (77°F)
Weight	Approx. 4.1 kg(9.04 lbs)
Maximum Discharge Current	150A/180A(5sec)
Internal Resistance	Approx. 14 mΩ
Operating Temperature Range	Discharge: -15°C~50°C (5°F~122°F) Charge: -15 °C~40°C (5°F~104°F) Storage: -15°C~40°C (5°F~104°F)
Nominal Operating Temperature Range	25°C±3°C (77°F±5°F)
Float Charging Voltage	13.5 to 13.8 VDC/unit Average at 25°C (77°F)
Recommended Maximum Charging Current Limit	3.6A
Equalization and Cycle Service	14.4 to 15.0 VDC/unit Average at 25°C (77°F)
Self Discharge	CSB Batteries can be stored for more than 6 months at 25°C (77°F) . Please charge batteries before using . For higher temperatures the time interval will be shorter.
Terminal	F1/F2-Faston Tab187/250
Container Material	ABS(UL 94-HB/File E50263)*Flammability resistance of (UL 94-V0/File E88637) can be available upon request.



MH14533(N)



ISO9001
No.:041005117



ISO 14001
NO.UM 1-12-0045

CSB-manufactured VRLA batteries are UL-recognized components under UL924 and UL1989.

CSB is also certified by ISO 9001 and ISO 14001.

► Dimensions :

Overall Height (H)	Container height (h)	Length (L)	Width (W)	
Unit: mm (inch)	100±1 (3.94±0.04)	94±1 (3.7±0.04)	151±2 (5.94±0.08)	98±1 (3.85±0.04)

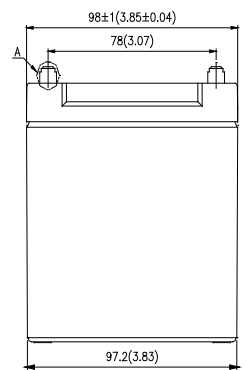
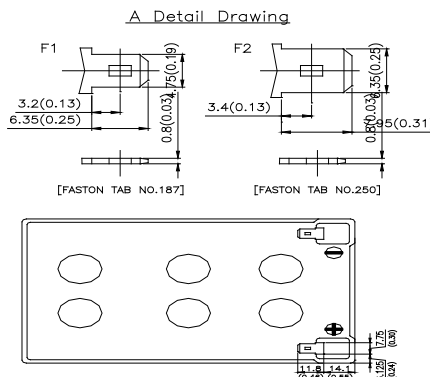
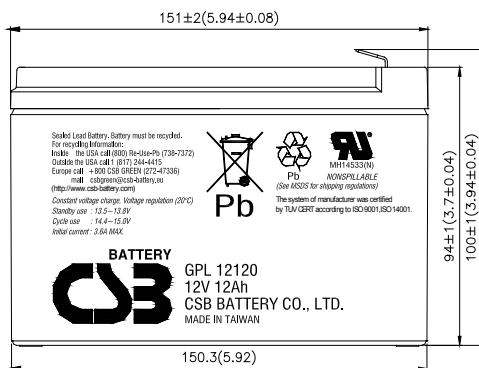

Constant Current Discharge Characteristics Unit:A (25°C ,77°F)

F.V/Time	5MIN	10MIN	15MIN	30MIN	1HR	2HR	3HR	4HR	5HR	8HR	10HR	20HR
1.60V	45.7	32.1	23.1	13.5	7.43	4.00	2.84	2.22	1.84	1.25	1.03	0.612
1.67V	44.0	31.4	23.0	13.4	7.32	3.96	2.82	2.19	1.83	1.24	1.02	0.610
1.70V	42.8	30.8	22.6	13.2	7.27	3.94	2.80	2.18	1.82	1.23	1.01	0.608
1.75V	40.3	29.4	21.9	13.0	7.14	3.89	2.77	2.16	1.81	1.22	1.00	0.600
1.80V	37.6	27.5	20.7	12.6	6.93	3.81	2.70	2.12	1.78	1.21	0.979	0.593
1.85V	33.8	24.8	19.0	11.7	6.56	3.64	2.59	2.04	1.70	1.14	0.931	0.566

Constant Power Discharge Characteristics Unit:W (25°C ,77°F)

F.V/Time	5MIN	10MIN	15MIN	30MIN	1HR	2HR	3HR	4HR	5HR	8HR	10HR	20HR
1.60V	487	343	258	152	84.6	46.9	33.4	26.1	21.7	14.7	12.2	6.31
1.67V	475	339	255	151	84.5	46.6	33.2	26.0	21.6	14.6	12.1	6.25
1.70V	466	333	252	150	84.1	46.1	33.1	25.9	21.5	14.5	12.0	6.23
1.75V	443	322	246	149	83.5	46.0	32.9	25.7	21.4	14.4	11.8	6.19
1.80V	416	306	235	144	81.0	44.9	32.0	25.2	21.0	14.2	11.6	6.09
1.85V	380	280	217	135	77.0	43.0	30.7	24.2	20.4	13.7	11.2	5.86

Trickle (or Float) Service Life

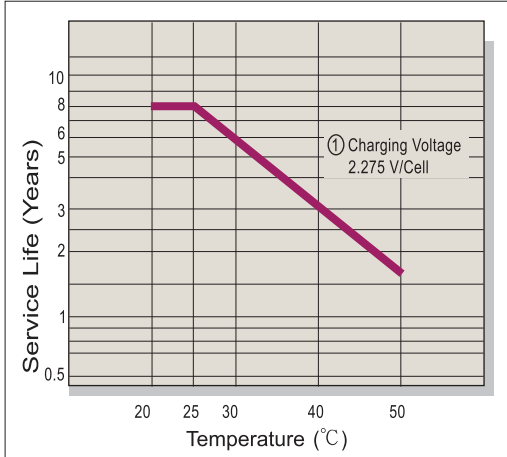

Capacity Retention Characteristic

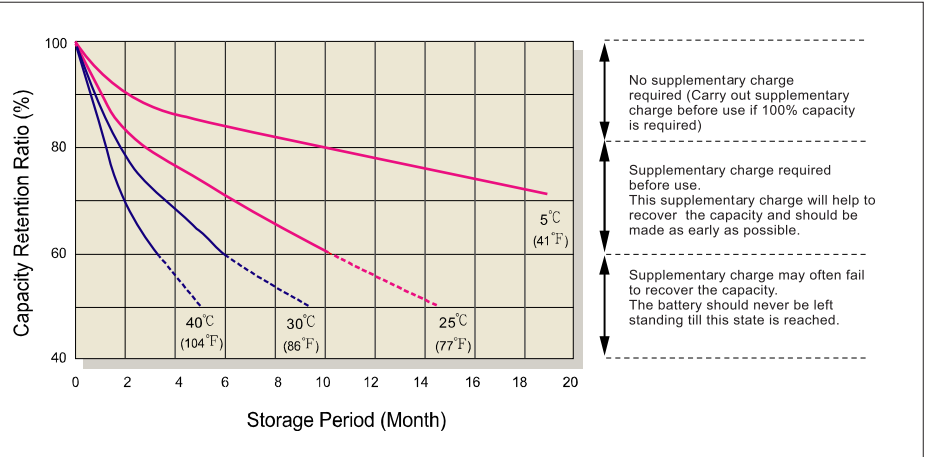

Battery Voltage and Charge Time for Standby Use

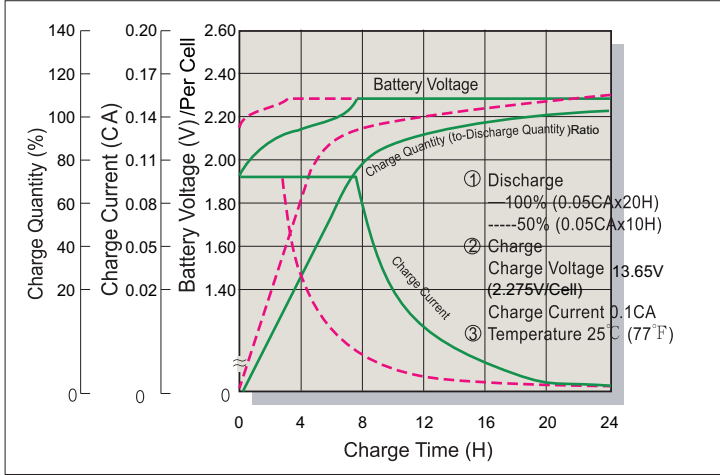

Cycle Service Life

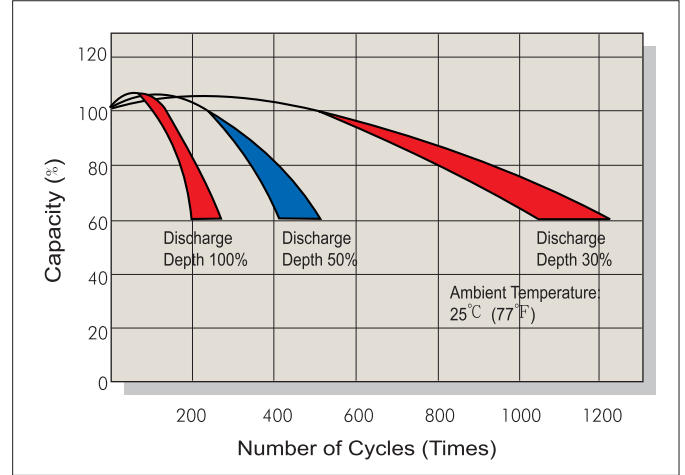

Battery Voltage and Charge Time for Cycle Use

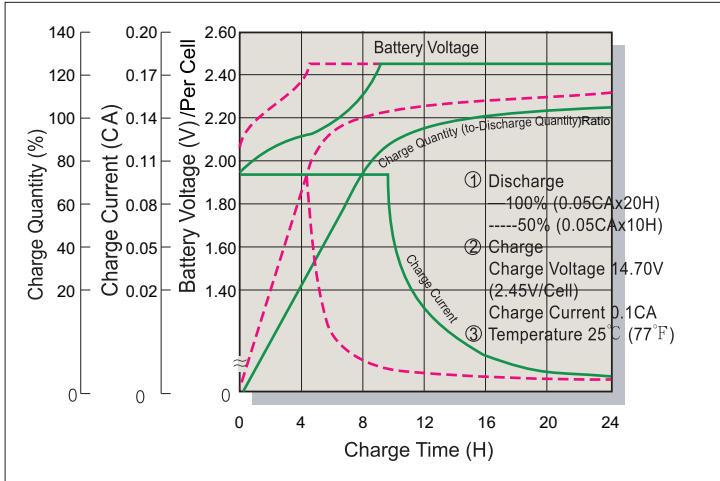

Terminal Voltage (V) and Discharge Time

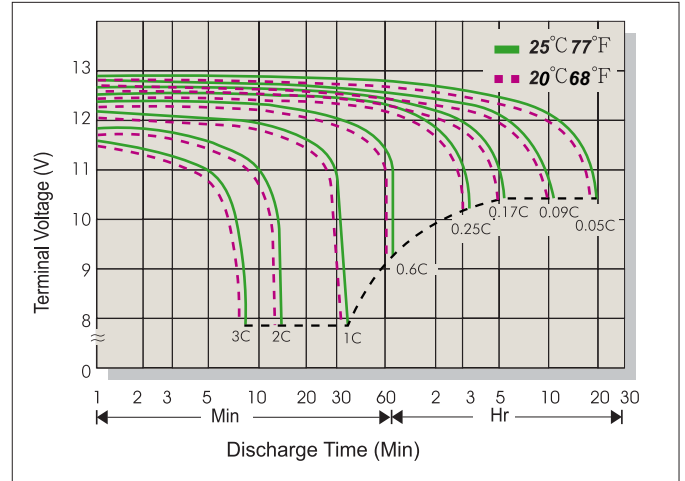

Charging Procedures

Application	Charge Voltage(V/Cell)			Max.Charge Current
	Temperature	Set Point	Allowable Range	
Cycle Use	25°C(77°F)	2.45	2.40~2.50	0.3C
Standby	25°C(77°F)	2.275	2.25~2.30	

Discharge Current VS. Discharge Voltage

Final Discharge Voltage V/Cell	1.75	1.70	1.60	1.30
Discharge Current(A)	0.2C>(A)	0.2C<(A)<0.5C	0.5C<(A)<1.0C	(A)>1.0C

Sales Office URL: WWW.CSB-BATTERY.COM

GLOBAL HQ
CSB BATTERY CO., LTD. (TAIWAN)
 Tel : +886-2-2555-5600
 Fax : +886-2-2555-3300
 mail : service@csb-battery.com.tw

BEIJING OFFICE. (CHINA)
CSB BATTERY TECHNOLOGIES (BEIJING) CO., LTD.
 Tel : +86-10-59621300/1301/1302/1303
 Fax : +86-10-59621304
 mail : chinasl@csb-battery.com

AMERICA HQ
CSB BATTERY TECHNOLOGIES INC. (U.S.A)
 Tel : +1-817-244-7777/1-(800)3-CSB-USA(272872)
 Fax : +1-817-244-4445
 mail : csb@csb-battery.com

SHANGHAI OFFICE. (CHINA)
CSB BATTERY LOGISTIC (SHANGHAI) CO., LTD.
 Tel : +86-21-5046-1622/5046-0833
 Fax : +86-21-5064-3314
 mail : chinasl@csb-battery.com

EUROPE HQ
CSB Battery Europe BV.
 Tel : +31(0)-180-418-140
 Fax : +886-2-2555-3300
 mail : eurosales@csb-battery.eu

SHENZHEN OFFICE. (CHINA)
CSB BATTERY LOGISTIC (SHANGHAI) CO., LTD.
 Tel : +86-755-8831-6488/6396/6356
 Fax : +86-755-8831-6548
 mail : she@csb-battery.com.cn