

Powered by



# HC 1228W ▶ 12V 28W

HC 1228W is specially designed for high efficient discharge application. Its invisible terminals can be inserted PC board directly. HC series battery can serve more than 260 cycles at 100% discharge in cycle service, up to 5 years in standby service.



## ► Specification

<b>Cells Per Unit</b>	6
<b>Voltage Per Unit</b>	12
<b>Capacity</b>	28W @ 15min-rate to 1.67V per cell @25°C (77°F)
<b>Weight</b>	Approx.2.51 kg(5.53 lbs)
<b>Maximum Discharge Current</b>	60A(5sec)
<b>Internal Resistance</b>	Approx. 21mΩ
<b>Operating Temperature Range</b>	Discharge: -15°C~50°C ( 5°F~122°F) Charge: -15°C~40°C ( 5°F~104°F) Storage: -15°C~40°C ( 5°F~104°F)
<b>Nominal Operating Temperature Range</b>	25°C±3°C(77°F±5°F)
<b>Float Charging Voltage</b>	13.5 to 13.8 VDC/unit Average at 25°C(77°F)
<b>Recommended Maximum Charging Current Limit</b>	2.8A
<b>Equalization and Cycle Service</b>	14.4 to 15.0 VDC/unit Average at 25°C(77°F)
<b>Self Discharge</b>	CSB Batteries can be stored for more than 6 months at 25°C(77°F). Please charge batteries before using. For higher temperatures the time interval will be shorter.
<b>Terminal</b>	C1-Faston Tab187/250
<b>Container Material</b>	ABS(UL 94-HB/File E50263)*Flammability resistance of (UL 94-V0/File E88637) can be available upon request.



CSB-manufactured VRLA batteries are UL-recognized components under UL924 and UL1989.

CSB is also certified by ISO 9001 and ISO 14001.

Dimensions :	Overall Height (H)	Container height (h)	Length (L)	Width (W)
Unit: mm (inch)	127.5±1.5 (5.0±0.06)	126±1.5 (4.96±0.06)	139.7±1.5 (5.5±0.06)	48±1.0 (1.89±0.04)

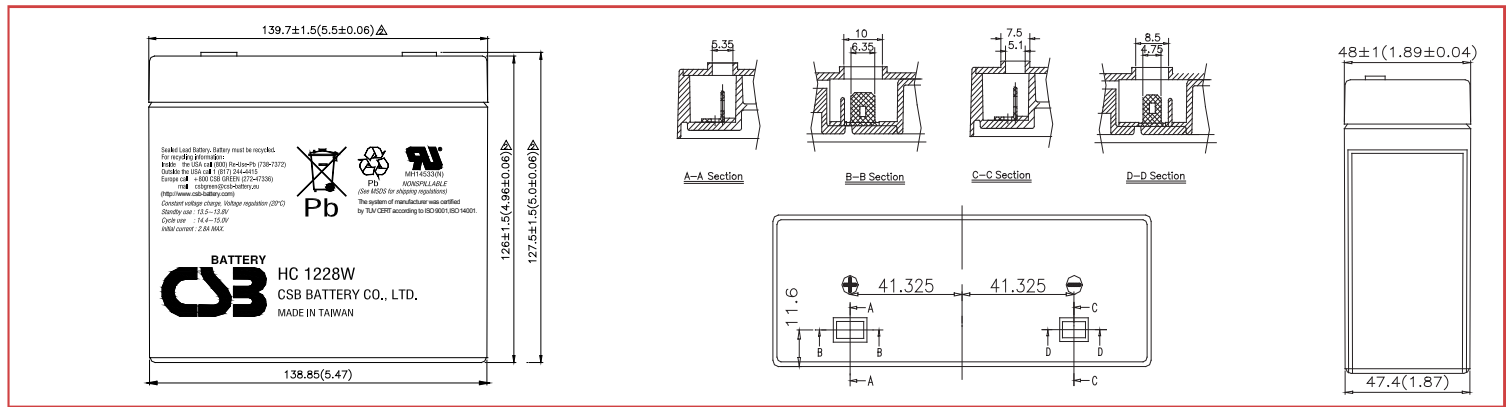

## Constant Current Discharge Characteristics Unit:A (25°C, 77°F)

F.V/Time	2MIN	4MIN	6MIN	8MIN	10MIN	15MIN	20MIN	30MIN	60MIN	90MIN
1.60V	48.6	38.2	31.3	27.2	23.3	18.0	14.9	11.6	7.33	4.75
1.67V	46.9	36.8	30.2	26.3	22.7	17.5	14.7	11.5	7.26	4.59
1.70V	45.2	35.4	29.3	25.5	22.1	17.0	14.4	11.4	7.19	4.43
1.75V	43.4	34.0	28.2	24.5	21.4	16.6	14.2	11.3	7.12	4.29
1.80V	41.4	32.6	27.1	23.6	20.8	16.3	14.0	11.2	7.03	4.14
1.85V	39.4	30.9	26.0	22.7	20.1	16.0	13.8	11.1	6.92	4.00

## Constant Power Discharge Characteristics Unit:W (25°C, 77°F)

F.V/Time	2MIN	4MIN	6MIN	8MIN	10MIN	15MIN	20MIN	30MIN	60MIN	90MIN
1.60V	583	458	375	326	280	212	175	139	89.5	57.0
1.67V	563	442	361	315	273	207	173	138	88.6	55.1
1.70V	544	425	349	304	265	202	170	137	87.7	53.2
1.75V	522	408	337	293	258	197	167	135	86.8	51.5
1.80V	498	391	325	280	248	193	164	134	86.0	49.7
1.85V	473	371	312	268	239	187	161	133	85.1	48.0

### Trickle (or Float) Service Life

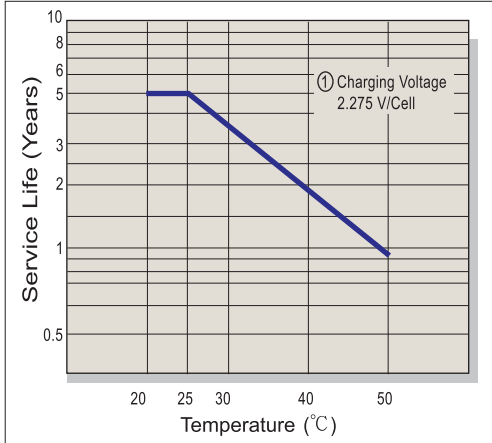

### Capacity Retention Characteristic

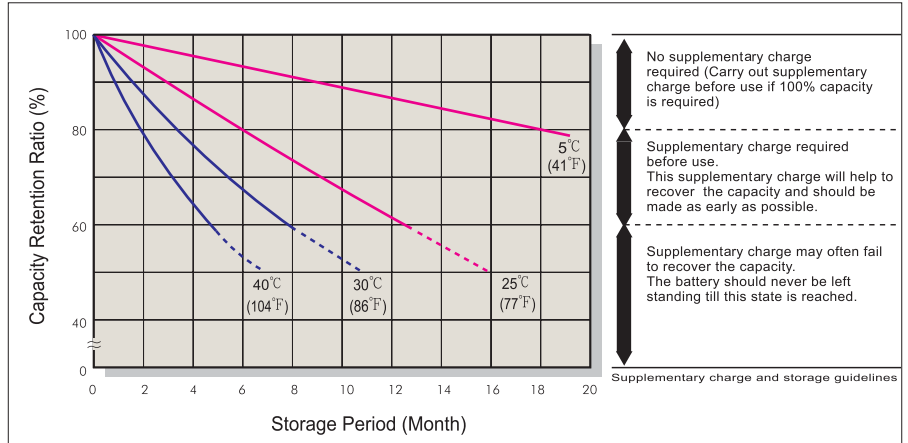

### Battery Voltage and Charge Time for Standby Use

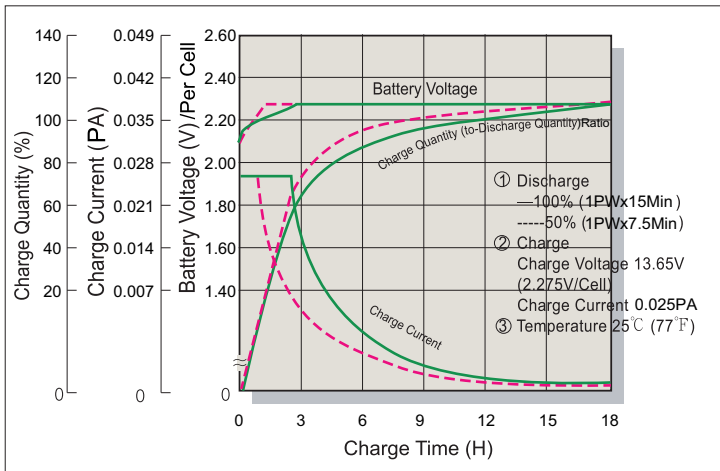

### Cycle Service Life

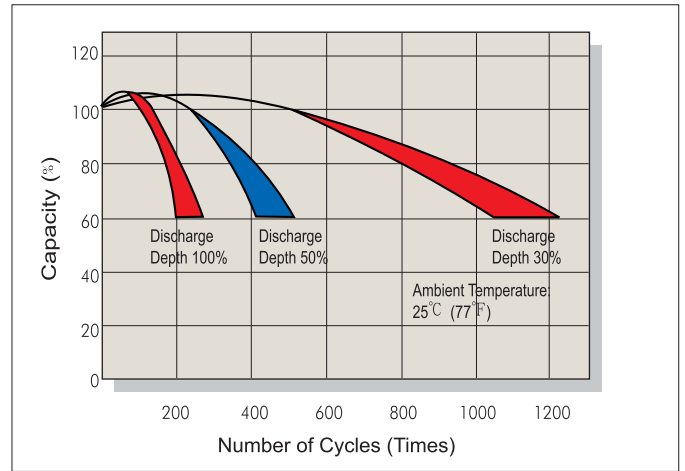

### Battery Voltage and Charge Time for Cycle Use

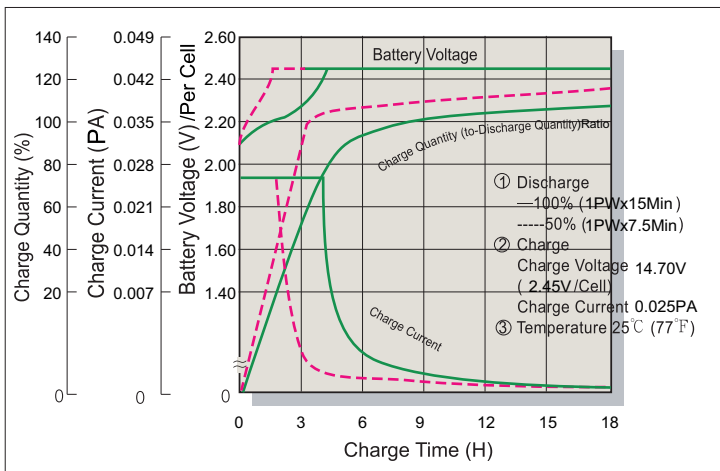

### Terminal Voltage (V) and Discharge Time

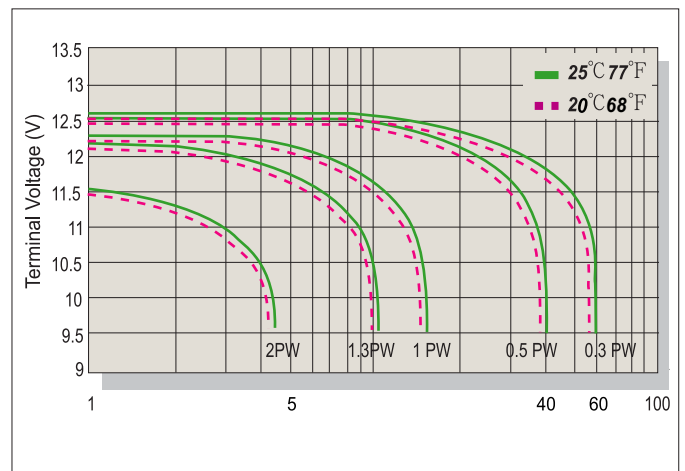

### Charging Procedures

Application	Charge Voltage(V/Cell)			Max.Charge Current
	Temperature	Set Point	Allowable Range	
Cycle Use	25°C (77°F)	2.45	2.40~2.50	0.1PA
Standby	25°C (77°F)	2.275	2.25~2.30	

### Discharge Current VS. Discharge Voltage

Final Discharge Voltage V/Cell	1.75	1.70	1.60	1.30
Discharge Power(W)	0.1P>(W)	0.1P≤(W)<0.25P	0.25P≤(W)<1.0P	(W)≥1.0P

Sales Office URL: [WWW.CSB-BATTERY.COM](http://WWW.CSB-BATTERY.COM)

**GLOBAL HQ**  
**CSB BATTERY CO., LTD. (TAIWAN)**  
 Tel : +886-2-2555-5600  
 Fax : +886-2-2555-3300  
 mail : service@csb-battery.com.tw

**BEIJING OFFICE. (CHINA)**  
**CSB BATTERY TECHNOLOGIES (BEIJING) CO., LTD.**  
 Tel : +86-10-59621300/1301/1302/1303  
 Fax : +86-10-59621304  
 mail : chinasl@csb-battery.com

**AMERICA HQ**  
**CSB BATTERY TECHNOLOGIES INC. (U.S.A)**  
 Tel : +1-817-244-7777/1-(800)3-CSB-USA(272872)  
 Fax : +1-817-244-4445  
 mail : csb@csb-battery.com

**SHANGHAI OFFICE. (CHINA)**  
**CSB BATTERY LOGISTIC (SHANGHAI) CO., LTD.**  
 Tel : +86-21-5046-1622/5046-0833  
 Fax : +86-21-5064-3314  
 mail : chinasl@csb-battery.com

**EUROPE HQ**  
**CSB Battery Europe BV.**  
 Tel : +31(0)-180-418-140  
 Fax : +886-2-2555-3300  
 mail : eurosales@csb-battery.eu

**SHENZHEN OFFICE. (CHINA)**  
**CSB BATTERY LOGISTIC (SHANGHAI) CO., LTD.**  
 Tel : +86-755-8831-6488/6396/6356  
 Fax : +86-755-8831-6548  
 mail : she@csb-battery.com.cn